



NOVATOP EASY BOARD
Technical documentation

SUPPORT FOR YOU

SAMPLES



150 x 420 x 40/60 mm



You can order samples at novatop@agrop.cz

ON-LINE



Product



Technical
documentation



Certificates



3D library



Assembly
instructions

EASY BOARD CONTENT

TECHNICAL DOCUMENTATION

1	Technical information	
	Data sheet	4
	Machining details	5
	Wood	6
	Drilled profiles	7
	Brushing, formats	8
	Acoustics	9
	Fire resistance	10
	Surface finishes	11
	Quality Specifications	13
2	Examples of application	
	Examples of application	15
3	Mechanical and physical properties	
	Characteristic properties	20
4	Other	
	Production, packaging, transportation, handling, storage, use, maintenance, warranty	22
	NOVATOP Quality	26
5	Assembly instructions	
	Assembly instructions	28

Warning:

All rights reserved for technical changes, typesetting and printing errors. The colour of the images may differ from the original due to printing.

Warning:

You can find the current technical documentation on the website in downloads section.

CONTENT

3-layer panel with a spring, a groove and a chamfered edge

Requirements	EN 13353, EN 13986:2004+A1:2015 CE
Operation classes	SWP/1, SWP/2, SWP/3 according to EN 13353
Types of trees	local spruce, fir
Gluing	AW100 according to DIN 68705, SWP/3 according to EN 13354, D4 according to EN 204
Glue	Spruce – PVAC, Melamine adhesive Fir – PVAC
Quality	PREMIUM: Spruce, Fir BASE: Spruce The back side of the panel is always non-visual Quality specifications are defined in accordance with internal regulations of AGROP NOVA a.s.
Standard thicknesses (mm)	19 (6-7-6), 27 (9-9-9)
Standard formats (mm)	Gross: 625 x 2500, 625 x 3000, 1250 x 2500, 1250 x 3000, 1250 x 5000, 1250 x 6000 Net: 615 x 2490, 615 x 2990, 1240 x 2490, 1240 x 2990, 1240 x 4990, 1240 x 5990
Dimensional tolerance	Machining tolerance in the thickness of ± 0.2 mm Tolerance of sanding thickness of ± 0.2 mm Width and length tolerance of ± 0.5 mm
Surface	Sanded – K 50, 100
Humidity	spruce, fir 8 ± 2 %
Density	spruce, fir, approx. 490 Kg/m ³
Formaldehyde emission class	E1 according to EN 717-1, EN16516 for values refer to the test reports
Reaction to fire	D-s2, d0 according to EN 13 501-1
Design value of thermal conductivity (λ)	0.13 W/mK, at a density of 490 kg/m ³ according to EN 12524 – spruce, fir
Factor of diffusion resistance (μ)	200/70 (dry/wet) according to EN ISO 10456
Sound absorption	250 – 500 Hz – 0,1 1000 – 2000 Hz – 0,3
Airborne sound insulation (dB)	$R = 13 \times \log(m_a) + 14$ m_a – surface weight kg/m ²
Specific heat capacity (c_p)	1,600 J/kgK according to EN ISO 10456

EASY BOARD MACHINING DETAILS

CONTENT

Machining of edges – 4 sides

EASY BOARD 19 mm

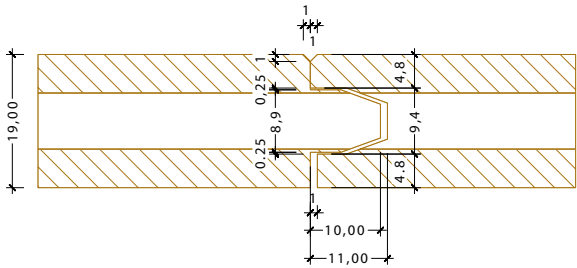

EASY BOARD 27 mm

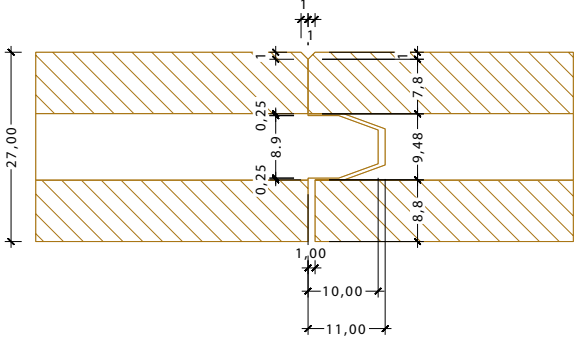

Industrial design registration number: 015020522-0001

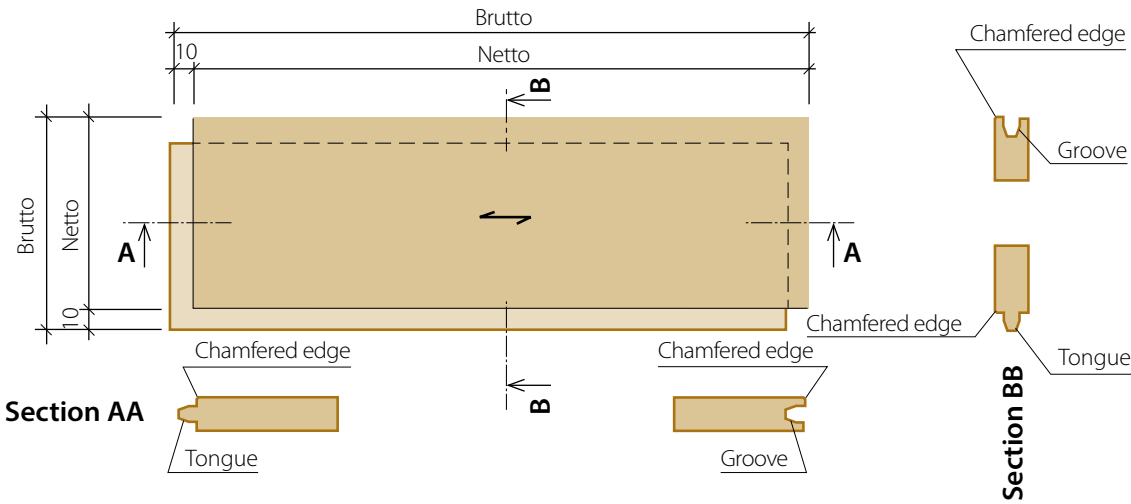

Machining tolerance in the thickness of ± 0.2 mm
 Tolerance of sanding thickness of ± 0.2 mm
 Width and length tolerance of ± 0.5 mm

CONTENT

PREMIUM

- > **Spruce** (Melamine, PVAC adhesive)
- > **Fir** (PVAC adhesive)
- > **Surface quality:** visual furniture, closed and puttied surface, without colouration, repairs with natural knots, sanded,

machining with an accuracy of ± 0.2 mm.

The back side is always non-visual.

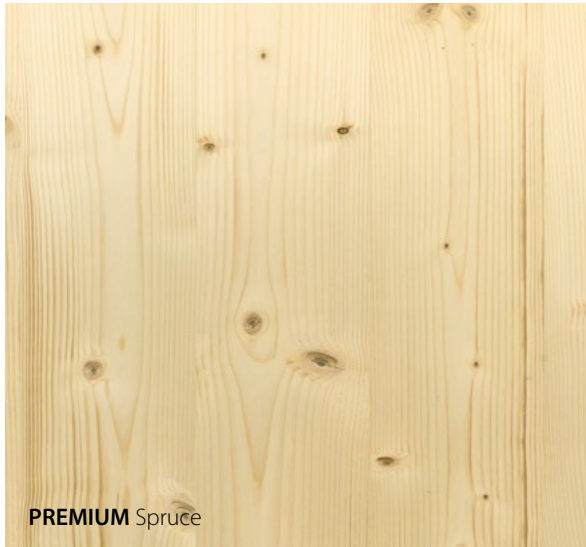

PREMIUM Spruce

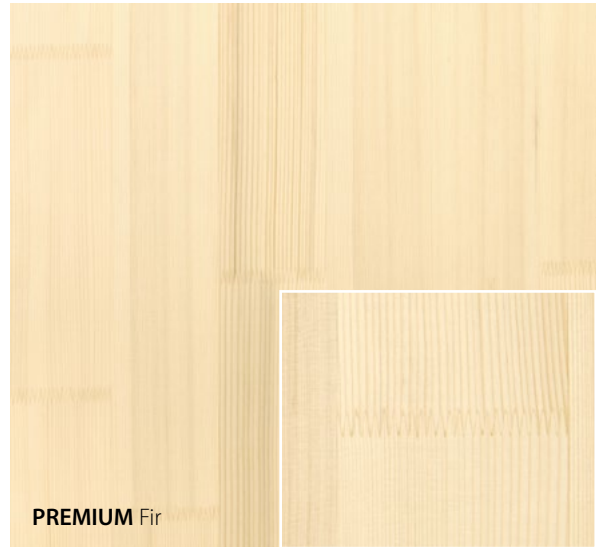

PREMIUM Fir

BASE

- > **Spruce** (Melamine, PVAC adhesive)
 - > **Quality:** lower demands on visual quality, permissible chipped knots or lamellas, machining with an accuracy of ± 0.5 mm
- The back side is always non-visual.**

Permissible defects (examples)



BASE Spruce



EASY BOARD DRILLED PROFILES

CONTENT

1
2
3
4
5

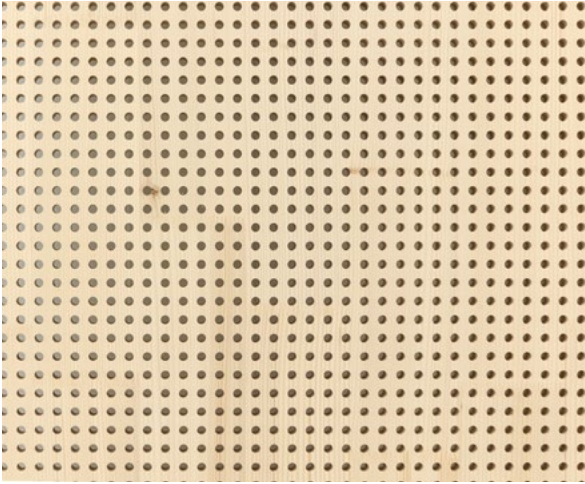

Profile 8/16-16

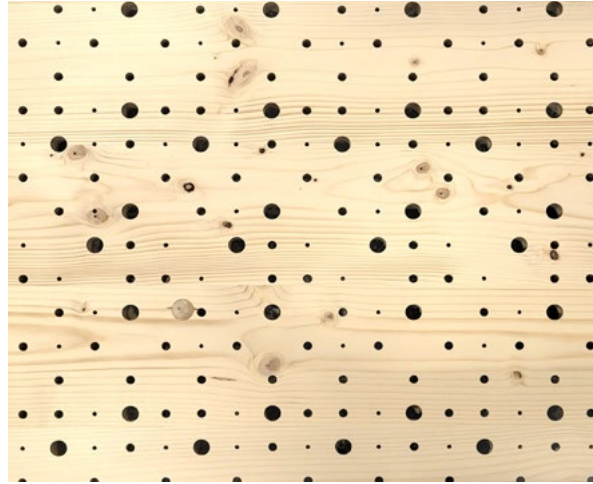

KATY – random drilling of \varnothing 4, 8, 16 mm

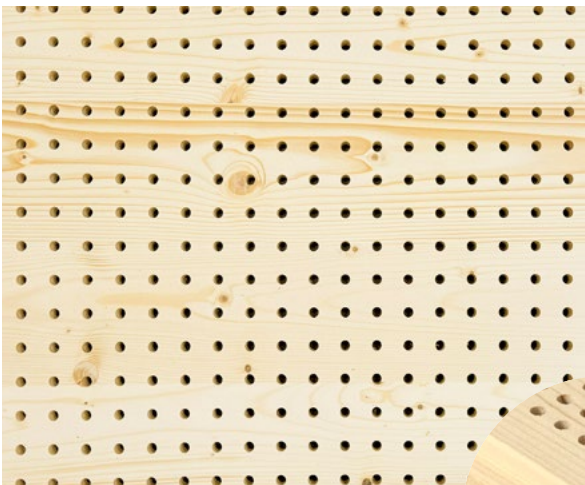

Profile 10/32-32

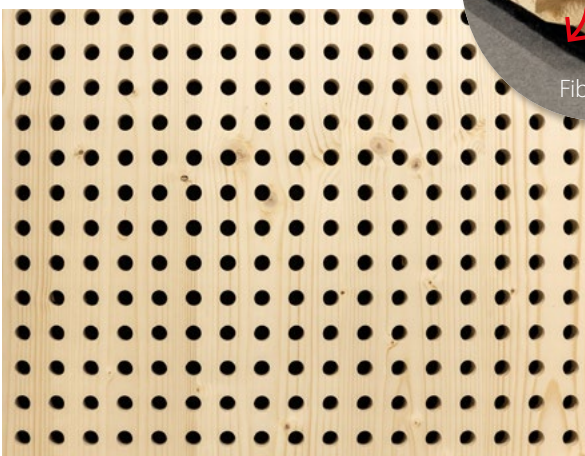

Profile 16/32-32

S/L Profile – visual side: the 4/12 grooving,
non-visual side: the 16/32-32 drilling
Wood: only fir

Drilled profiles can be supplemented with a black Fibertex absorber of 450 g on the non-visual side.

CONTENT

1

Brushing

Wood: spruce, fir



2

3

Formats

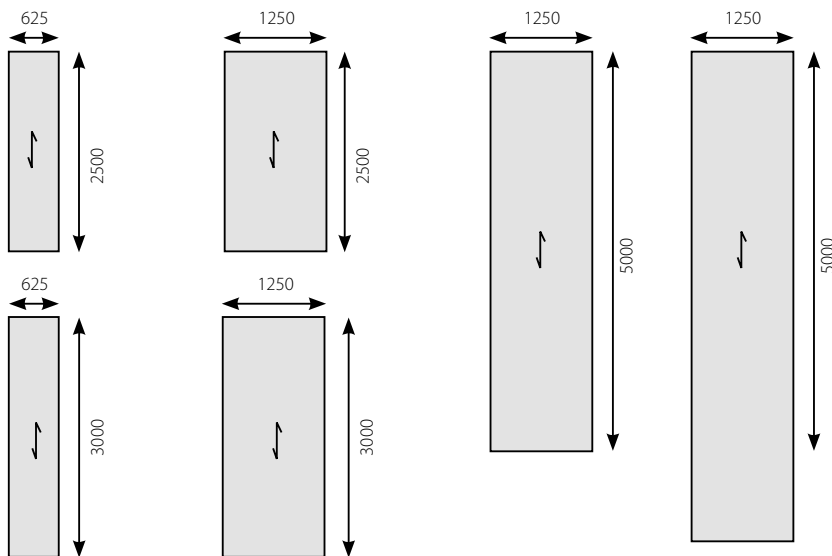

4

Gross: 625 x 2500, 625 x 3000, 1250 x 2500, 1250 x 3000, 1250 x 5000, 1250 x 6000
 Net: 615 x 2490, 615 x 2990, 1240 x 2490, 1240 x 2990, 1240 x 4990, 1240 x 5990

5

EASY BOARD ACOUSTICS

CONTENT

PHYSICAL ACOUSTICS

Visual partition cladding with high airborne sound insulation between rooms.

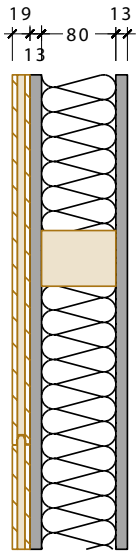

Internal wall 125 mm
EASY BOARD 19 mm
Fermacell 12.5 mm
KVH 60 x 80 mm (wooden substructure)
Mineral insulation 80 mm
Fermacell 12.5 mm

$R_w = 48$ dB

Report number: 415601639-01

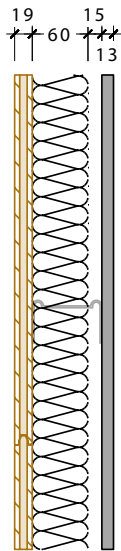

Internal wall 110 mm
EASY BOARD 19 mm
CW 75 mm
(metal substructure)
Mineral insulation 60 mm
Fermacell 12.5 mm

$R_w = 48$ dB

Report number: 415601639-02

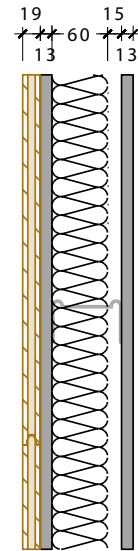

Internal wall 120 mm
EASY BOARD 19 mm
Fermacell 12.5 mm
CW 75 mm
(metal substructure)
Mineral insulation 60 mm
Fermacell 12.5 mm

$R_w = 54$ dB

Report number: 415601639-03

ROOM ACOUSTICS



Absorber Fibertex

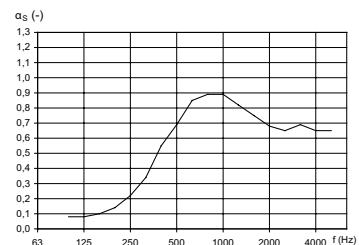

Report number 055/16

Composition of the panel:

EASY BOARD 19 mm
Wood: spruce
Profile: 8/16-16
Absorber: Fibertex 450

Sound absorption: α_w 0,55 | Class D

EASY BOARD FIRE RESISTANCE

CONTENT



Composition of the panel:

EASY BOARD 19 mm

Wood: spruce

Fireproof coating: Teknos

1. layer: KNOSAFE FLAME GUARD 2467-10

2. layer: TEKNOSAFE FLAME PROTECT 2468-00

Reaction to fire class: B-s1, d0

Format:

temporary length limit 2 m, longer on demand.

EASY BOARD SURFACE TREATMENTS

CONTENT

We offer various coating options according to the type of supplier in the design of **STANDARD** or **ON DEMAND**. Other surface treatment options are available only on the individual demand.

TYPES OF SURFACE TREATMENT:

Water-soluble glazing paint, UV stable

- Very low VOC (volatile organic compounds) values
- Highly transparent effect, stabilizes the natural appearance of wood
- Resistance to colour changes due to UV radiation.
- For more information, see the manufacturer's technical data sheets

ADLER LIGNOVIT INTERIOR UV 100					
Coating	Visual / non-visual side Number of layers		Execution	Application	
				Interior	Covered exterior
Basic	1/0	1/1	STANDARD	YES	NO
Final	-	2/1	ON DEMAND	YES	NO
SHADES					
NATUR	ZUGSPITZ		MONT BLANC		
Natural	White with a smaller proportion of pigment		White with a greater proportion of pigment		
TECHNICAL PARAMETERS					
Primer	1 layer applied manually with a roller, without edge protection		Amount 120–150 g/ m ²		
Final surface Visual/non-visual	2 layers of spray paint with intermediate sanding, without edge protection / 1 layer of spray paint		Amount 2x 80-90 g/ m ²		
Manufacturer's technical data sheet at: https://www.adler-lacke.com/					

SHERWIN-WILLIAMS LACROMA CLEAR 10					
Coating	Visual / non-visual side Number of layers		Execution	Application	
				Interior	Covered exterior
Basic	1/0	1/1	ON DEMAND	YES	NO
Final	-	2/1	STANDARD	YES	NO
SHADES					
NATUR	VENUS		POLARIS		
Natural	White with a smaller proportion of pigment		White with a greater proportion of pigment		
TECHNICAL PARAMETERS					
Primer	1 layer applied manually with a roller, without edge protection		Amount 70–90 g/ m ²		
Final surface Visual/non-visual	2 layers of spray paint with intermediate sanding, without edge protection / 1 layer of spray paint		Amount 65–75 g/ m ²		
Manufacturer's technical data sheet at: https://www.sherwin-williams.com/					

CONTENT

1
SAMPLER

Shades of glazes

The colour of the images is for reference only and may differ from the original due to printing.
Shades of glazes from other manufacturers and other colour options are only available upon individual request.

ADLER LIGNOVIT INTERIOR UV 100



Natur

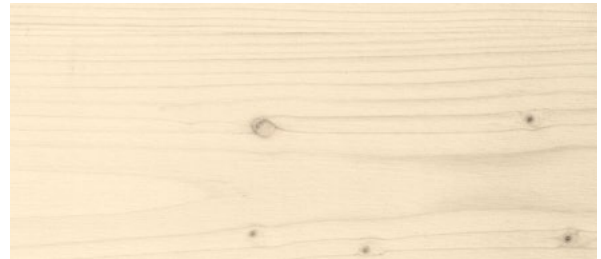

Zugspitz



MontBlanc

SHERWIN-WILLIAMS LACROMA CLEAR 10



Natur



Venus



Polaris

NOTES

CONTENT

Grid of dots for notes.

1

2

3

4

5

CONTENT

CLASSIFICATION OF QUALITY ACCORDING TO THE INTERNAL REGULATIONS OF AGROP NOVA A.S.

Znaky pro třídění	SPRUCE		FIR
	PREMIUM	BASE	PREMIUM
General requirements, longitudinal joints	flawless gluing without open joints	flawless gluing, repaired longitudinal joints allowed	flawless gluing without open joints
Structure, course of fibres, compression wood	finely grown, straight fibres, without compression wood	no special requirements	finely grown, straight fibres, without compression wood
Knottiness	healthy, firmly joint knots up to the diameter of 50 mm. Occasionally black knots-eyes allowed up to the diameter of 5 mm	no special requirements	healthy, firmly joint knots up to the diameter of 5 mm.
Repair natural knots	allowed up to the diameter of 20 mm 2 knots next to each other are not allowed	no special requirements	not allowed
Pitch pockets	occasionally allowed up to 2 x 30 mm	no special requirements	
Repaired pitch pockets	occasionally allowed above 2 x 30 mm repaired with a boat-shaped wedge	allowed above 5 x 50 mm repaired with a boat-shaped wedge	
Bark	not allowed, inbarks repaired up to 20 mm	occasionally allowed	not allowed
Cracks	shallow surface cracks occasionally allowed, open end cracks up to 50 mm of length occasionally allowed	no special requirements	shallow surface cracks occasionally allowed
Core /pith/	no pith	no special requirements	
Infestation with insect, worm	not allowed	not allowed, worm occasionally allowed	not allowed
Discolouration, fungus	not allowed	no special requirements rot not allowed	discolouration allowed in red, yellow, brown
Thickness of glued joints	max. 0,3 mm	no special requirements	max. 0,3 mm
Surface machining	occasionally allowed small defects	occasionally allowed small defects	no defects
Quality of the panel edge such as bulges, battered places	up to 10 mm from the edge occasionally allowed	up to 50 mm from the edge occasionally allowed	not allowed
Combination of different wood species	not allowed	allowed	not allowed
Width of individual parts - excluding the outer ones	at least 60 mm	no special requirements	at least 60 mm
Wood pattern	no special requirements	no special requirements	according to the colour and the structure uniform wood pattern
Machining	with an accuracy of ± 0.2 mm	with an accuracy of ± 0.5 mm	with an accuracy of ± 0.2 mm

EASY BOARD EXAMPLES OF APPLICATION

CONTENT

Wall cladding

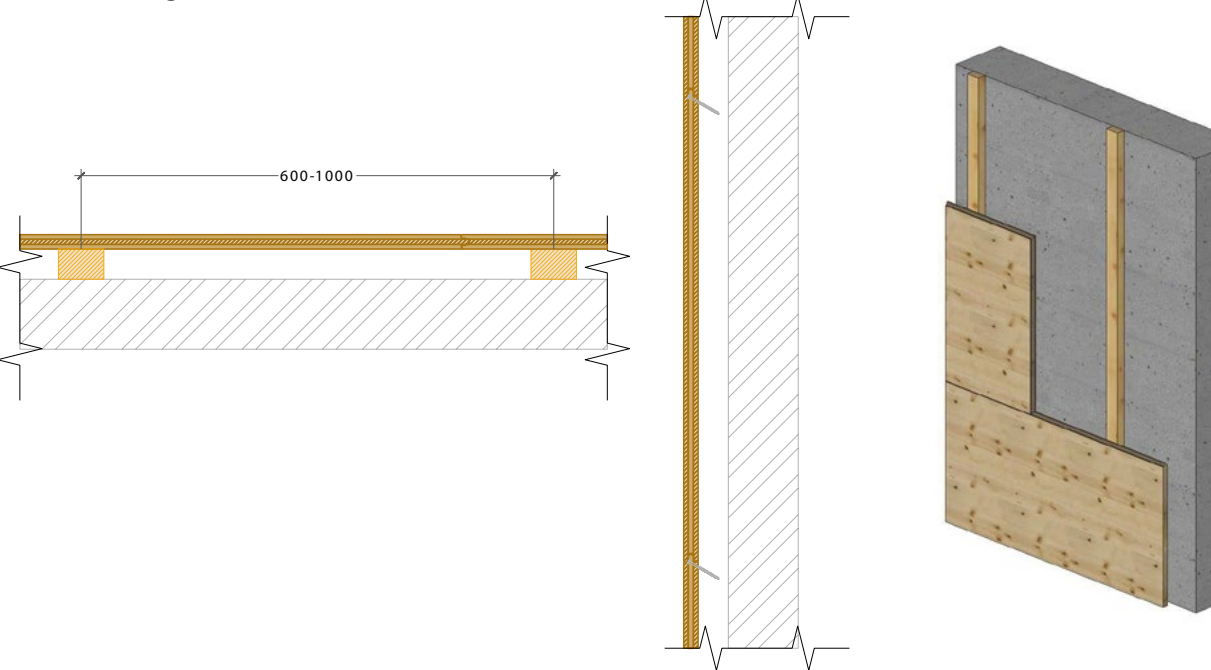

Pre-walls

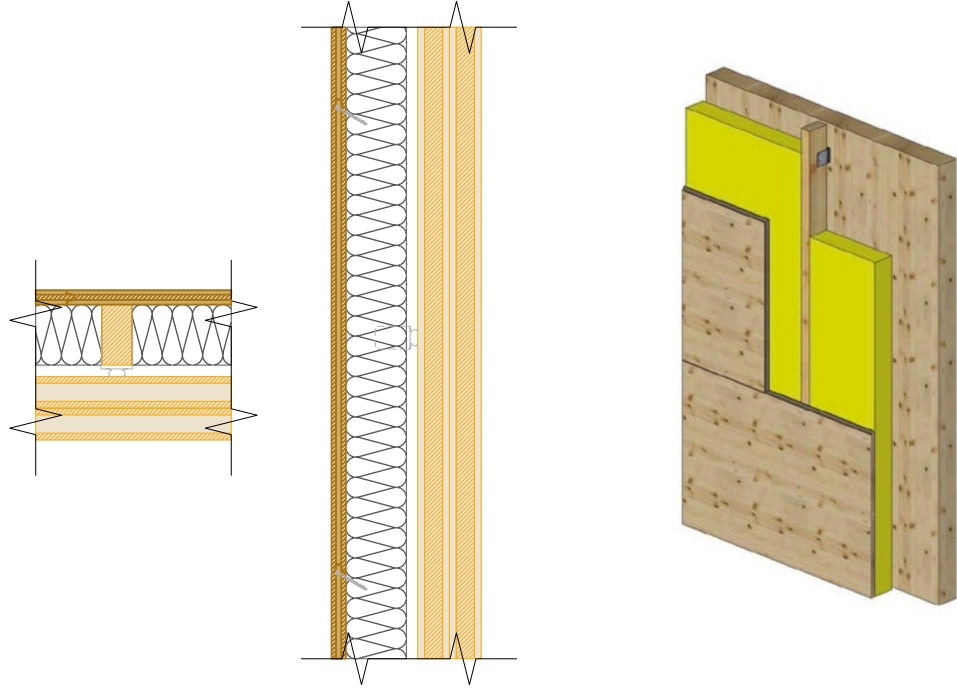

1

2

3

4

5

CONTENT

1

Cladding of frame structures – internal walls

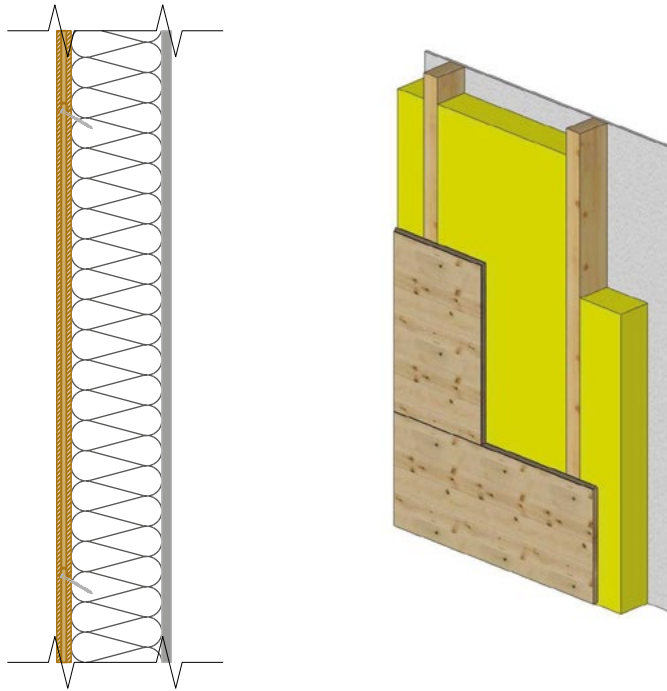

2

3

Cladding of frame structures – external walls

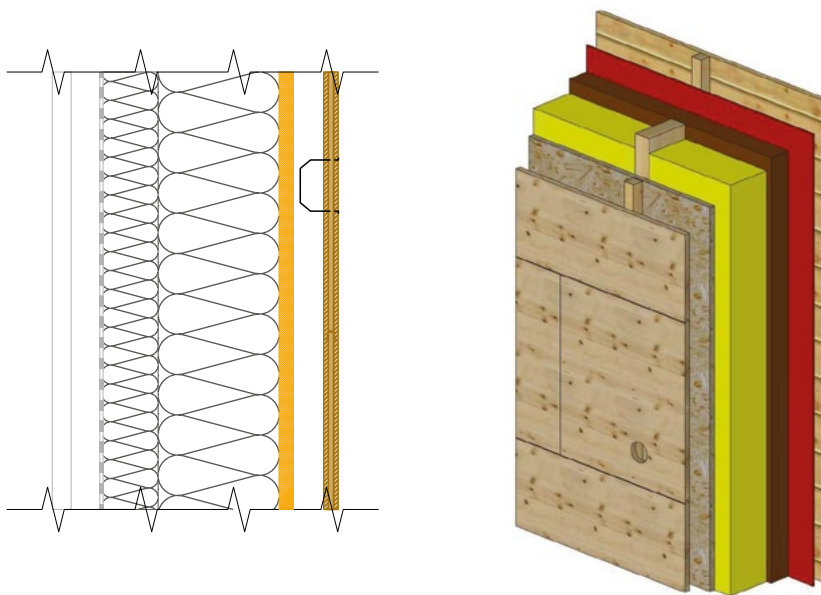

4

5

EASY BOARD EXAMPLES OF APPLICATION

CONTENT

Solid ceiling cladding

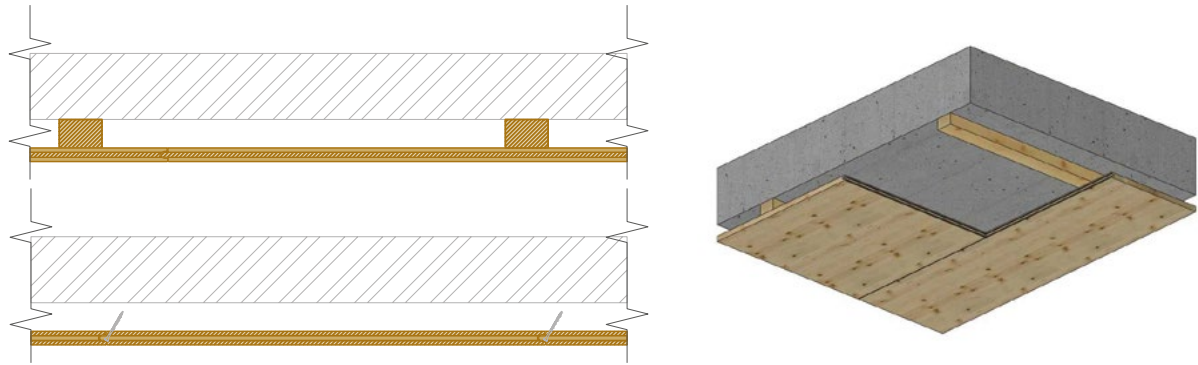

Wooden ceiling cladding

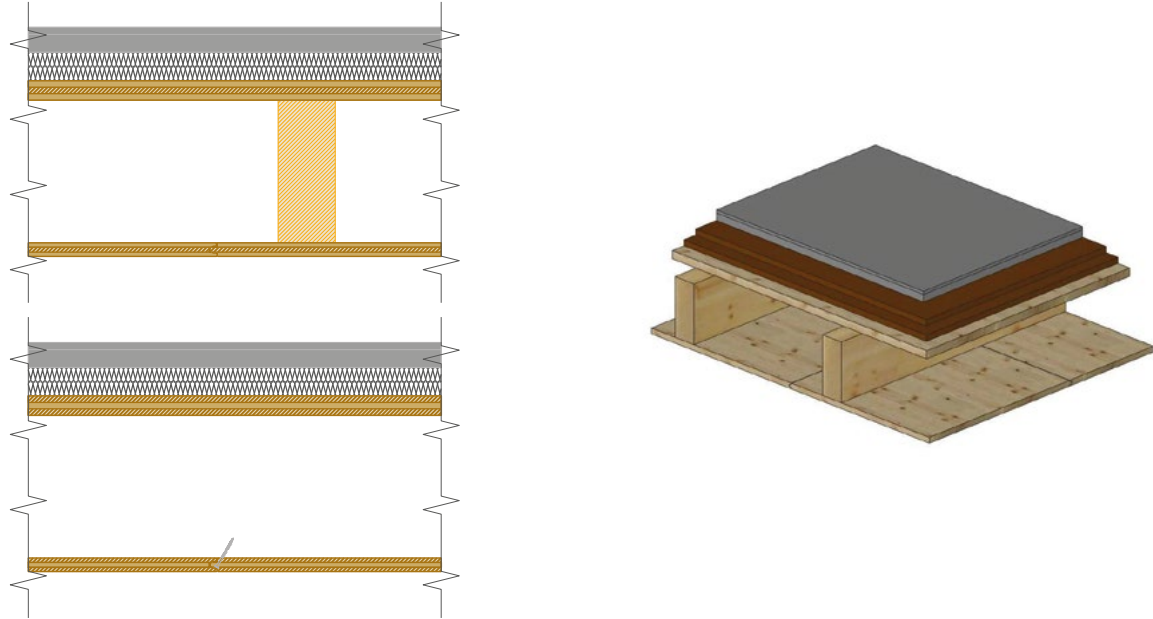

Ceiling decking

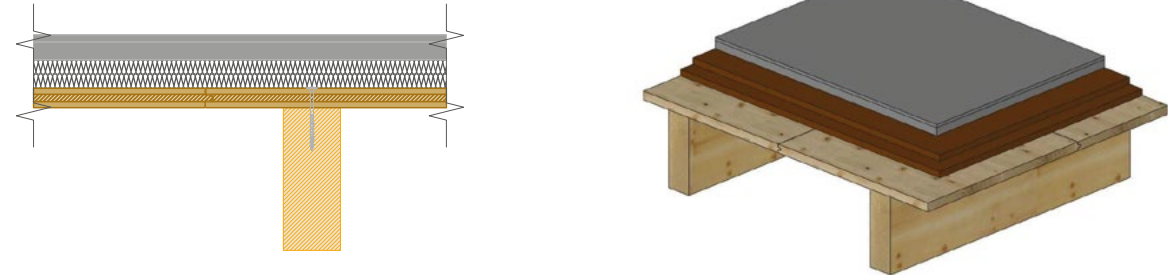

CONTENT

1 Clapboarding of the roofs

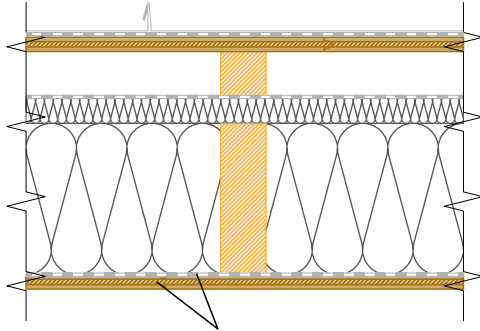

use of airtight foil or airtight execution of the joint

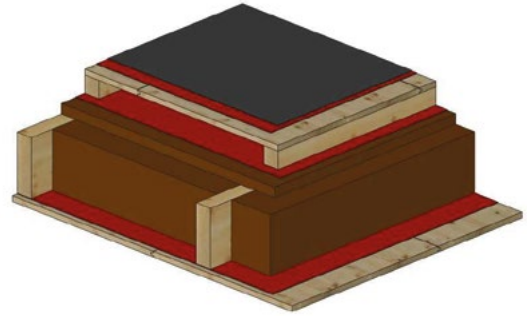

3 Roof decking

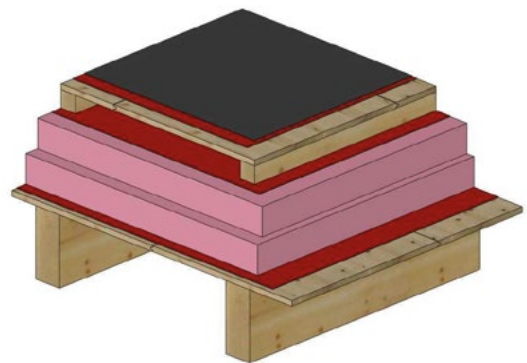
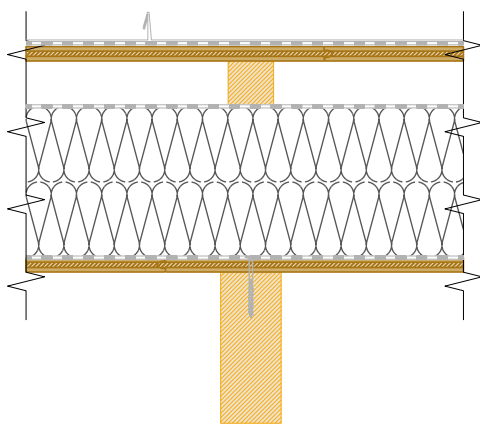

EASY BOARD EXAMPLES OF APPLICATION

CONTENT

Cladding of the covered exterior

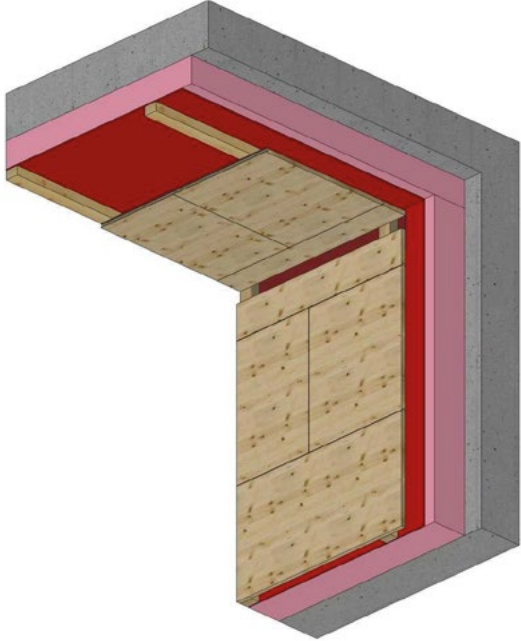
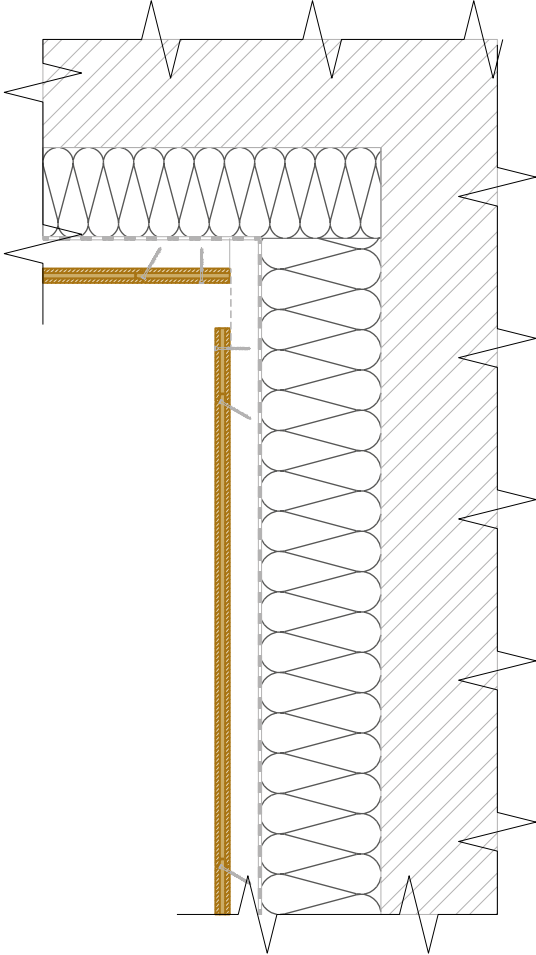

Floor covering

Warning: When used on floors, it is necessary to take into account the lower hardness and mechanical resistance of spruce wood.

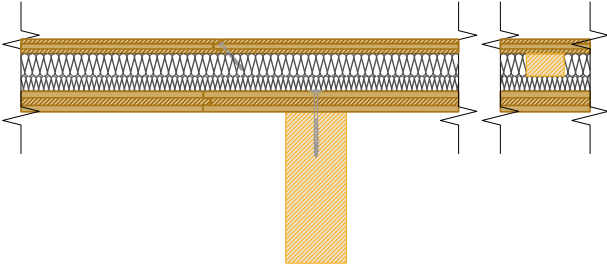

EASY BOARD CHARACTERISTIC PROPERTIES

CONTENT

Characteristic values of panels SWP/1 SD, SWP/2 SD, SWP/3 SD in N/mm²

Panels with butted joints in the middle layer

Type of panel	19 (6-7-6)	27 (9-9-9)
Number of layers	3	3
Thickness [mm]	19	27
Thickness of surface lamellas [mm]	6,0	9,0
Thickness of central lamellas [mm]	7,0	9,0

Stress perpendicular to the panel plane [N/mm²]

$f_{m,0,k}$	Bending strength parallel to the fibres of the outer layers	33,1	28,9
$f_{m,90,k}$	Bending strength perpendicular to the fibres of the outer layers	3,3	3,1
$E_{m,0}$	Modulus of elasticity parallel to the fibres of the outer layers	10900	11100
$E_{m,90}$	Modulus of elasticity perpendicular to the fibres of the outer layers	450	400
$f_{v,k}$	Shear strength	1,1	
G	Shear modulus of elasticity	90	

Stress in the panel plane [N/mm²]

$f_{m,0,k}$	Bending strength parallel to the fibres of the outer layers	19,3	20,3
$f_{m,90,k}$	Bending strength perpendicular to the fibres of the outer layers	5,8	5,3
$f_{t,0,k}$	Tensile strength parallel to the fibres of the outer layers	12,9	13,6
$f_{t,90,k}$	Tensile strength perpendicular to the fibres of the outer layers	3,9	3,6
$f_{c,0,k}$	Compressive strength parallel to the fibres of the outer layers	19,3	20,3
$f_{c,90,k}$	Compressive strength perpendicular to the fibres of the outer layers	5,8	5,3
$f_{v,k}$	Shear strength	3,0	
$E_{m,0}$	Modulus of elasticity parallel to the fibres of the outer layers	7400	7800
$E_{m,90}$	Modulus of elasticity perpendicular to the fibres of the outer layers	2250	2050
G	Shear modulus of elasticity	600	

Load diagram

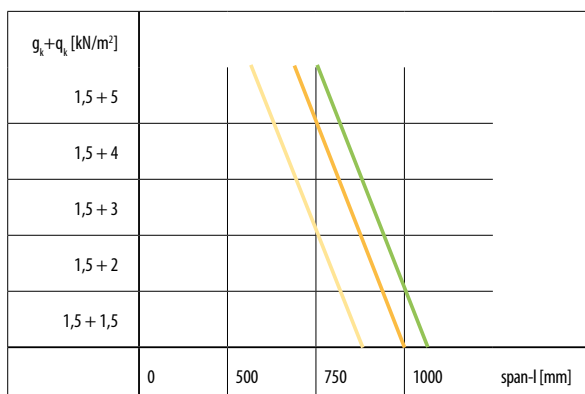

Girder of a single field:
Load perpendicular to the panel plane and transversally to the fibre direction of the surface layer.

19

27a (6-15-6)

27b 27b (9-9-9)

NOTES

CONTENT

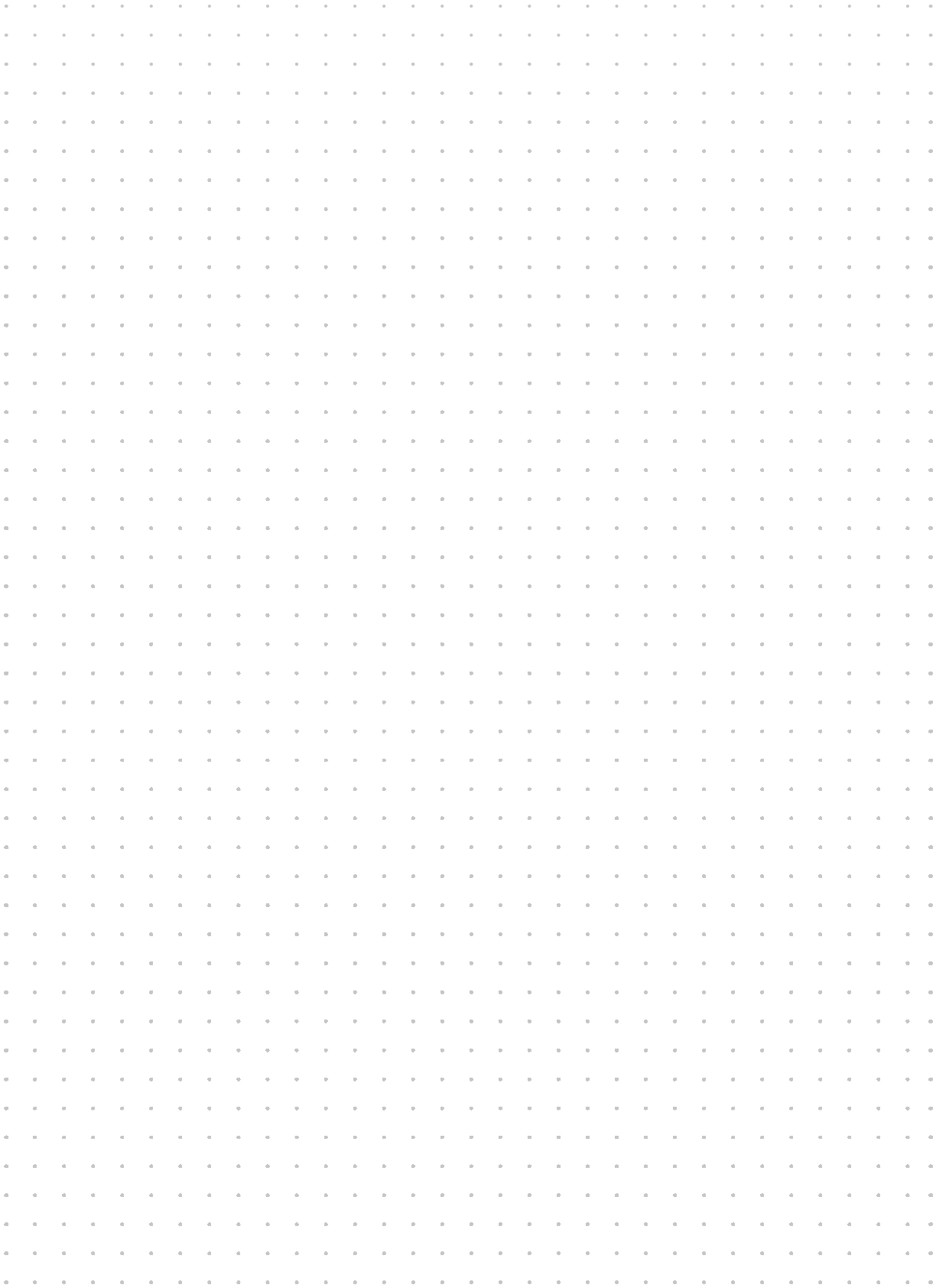

1

2

3

4

5

CONTENT

1 Production and quality control

NOVATOP EASY BOARD panels are made from three-layer NOVATOP SWP boards. SWP boards are made from lamellas of massive solid wood. The lamellas in the individual layers are glued together in both the longitudinal and transverse directions. The layers are rotated 90° relative to each other and then glued together. Each EASY BOARD panel is machined on four sides on a CNC machine using **a tongue, a groove and a chamfered edge of 1 mm**. The standard sanding quality corresponds to grain size of P100. The moisture content of the boards upon dispatch is $8\% \pm 2\%$.

Machining:

- Further machining of EASY BOARD panels is carried out by brushing, cutting, milling or drilling.

Surface treatment:

- The glazing paint is applied on one or both sides.
- A water-based glazing paint with a very low content of volatile organic compounds (VOC) is used.
- The glazing paint is resistant to discoloration caused by UV radiation.
- The type of glazing paint is determined according to the specifications of the supplier.
- The edges of the boards are not treated with glazing paint in the standard version.

Primer:

- Consists of one coat of glazing paint applied manually with a roller.
- May show minor colour variations and surface irregularities.
- Causes the fibres to stand up – intended for subsequent sanding.
- Serves to facilitate and accelerate final adjustments on the construction site.
- Provides partial protection against UV radiation.

Final coating:

- Is applied as a two-layer spray with intermediate sanding.
- The first layer is applied to a board sanded with P100 grit.
- Areas with different gleams (e.g. around knots) are common.
- The final coating is intended as a final finish, without the need for further treatment. Exceptions include repairs after installation or machining – these interventions are usually visually noticeable.

Warning:

Surface finishes undergo natural visual changes over time, such as a change in shade or loss of gloss. When combining different batches of glazing paints, possible differences in colour tone due to aging must be taken into account. Multiple batch combinations are usually visually noticeable and cannot be considered a manufacturing defect.

Each panel undergoes individual final quality control. Detailed specifications of the production technology are provided in a document entitled "**NOVATOP Quality**".

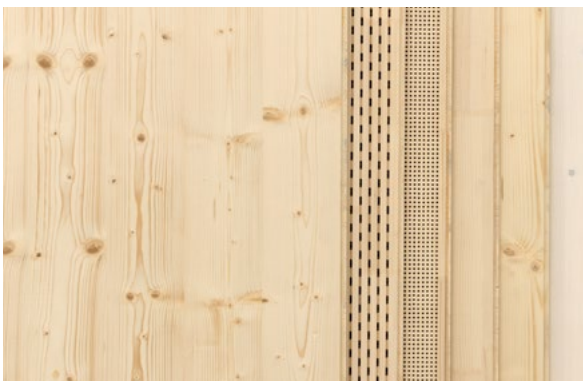



EASY BOARD OTHER

CONTENT

Packaging

- After the output inspection, the panels are placed into packages in wooden crates.
- In the package, the panels are stacked with the higher quality side facing up, and the top panel with the higher quality facing down.
- The bottom panel is placed on timber beams with a spacing of approximately 1 m.
- The package is wrapped in PE foil on all sides.
- The fronts of the package are covered with cardboard.
- The package is secured around its circumference with a strapping band.
- The package has edge protection and a stand in the middle of the package made of SWP panel.
- The identification label is placed on the longitudinal side of the package.
- Panels with surface treatment and veneer are individually interleaved with Mirelon (insulation material made of light-weight polyethylene foam).
- Packaging in a crate provides protection against changes in humidity and contamination, and offers partial protection against mechanical damage



NOVATOP 	
Package Nr.	 <small>NOVATOP 12 EN12955</small>
<hr style="border: 2px solid red;"/>	
Client:	_____
Object:	_____
Address:	_____
Description:	_____
_____	_____
_____	_____
_____	_____
_____	_____
Pcs.:	Date:
Weight:	Proportion:
	Control:
<small>Manufacturer: AGROP NOVA a.s., Pletenský Dvůrek 99, Pletná, Czech Republic, www.novatop-system.com</small>	

Transport

The standard method of transportation is in covered trucks or containers.

Handling

The packages solid wood panels (SWP) are designed for handling using front or side forklifts, or cranes.

Storage

- Store EASY BOARD panels in dry, closed and well-ventilated areas.
- Lay the panels horizontally, supported by wooden laths with a recommended spacing of approximately 1 m.
- After removing the protective PE packaging, carefully cover the panels with board material (e.g. MDF, OSB).
- For covering, we recommend using waterproof tarpaulins.
- During storage, the panels must be protected from rain and running water, dirt and direct sunlight.
- It is not permitted: to step on or place other materials or loads on the packages.
- **Warning:** Improper storage may result in permanent damage to the panels.

CONTENT

1 Application

EASY BOARD panels are designed for wall, ceiling and floor cladding in the interior and cladding in covered exteriors. The panels are ready for installation, see the recommended **assembly instructions**.

The panels are made of solid wood with an output moisture content of $8\% \pm 2\%$. Due to the preservation of the natural properties of wood, the panels can respond to changes in temperature and relative humidity with volume changes – shrinking, swelling or twisting.

- **Interior:** The recommended climate for using the panels indoors is a relative humidity of 40–60% at a temperature of 20 °C. Low humidity can lead to cracks in the wood.
- **Exterior:** The panels can only be used in covered exteriors and the natural reactions of wood to climatic conditions must be taken into account. The panels must be protected from direct exposure to moisture, such as condensate, running or dripping water, etc.
- **Machining:** The panels can be processed using standard woodworking tools and machines, just like solid wood – they can be drilled, cut, milled, sanded, or repaired. Wood dust comes into existence while machining.

3 Maintenance

- **Recommended climate in the interior:** relative humidity 40–60%, temperature of approx. 20 °C. Low humidity may cause cracks in the wood.
- For routine wood maintenance, use a soft dry cloth or a soft sponge.
- In case of moderate soiling, cleaning agents intended for wooden surfaces can be used.
- Local damage (e.g. alcohol marker, scratches) can be repaired by: fine sanding, followed by application of the same type of paint. Repairs are usually visually noticeable.

• **Surface treatment:**

- If the panels are not factory-coated, we recommend treating them with a suitable surface treatment intended for solid wood (e.g. glazing paints, oils, waxes).
- The surface treatment increases the panels' resistance to dirt and UV radiation and extends their aesthetic and functional life. Untreated wood naturally darkens due to oxidation and exposure to light.
- The application of surface treatment is governed by the technological procedure of the manufacturer of the selected coating.

Warning:

- Do not use excessive amounts of water.
- When placing decorations, paintings, shelves, etc., it is necessary to take into account that UV radiation may change the shade of the surrounding surface ("burning out" of the contours). Repairs are usually visually noticeable.
- Visual changes in the paint, such as a change in shade or loss of gloss, are a natural sign of aging and are not grounds for complaint.
- The panels must be protected from direct exposure to moisture, such as condensate from air conditioning, running or dripping water, etc.

1

2

3

4

5

EASY BOARD OTHER

[CONTENT](#)

Warranty

The warranty for EASY BOARD panels is governed by the valid **General Terms and Conditions of the Manufacturer** – AGROP NOVA a.s.

Warning: The manufacturer does not assume liability for any damage caused by:

- incorrect handling,
- improper storage,
- incorrect processing,
- improper use and maintenance.

Visual changes in the paint, such as a change in shade or loss of gloss, are a natural sign of aging and are not grounds for complaint.

Business documents:



Complaint
report



General terms
and conditions

1

2

3

4

5

CONTENT

NOVATOP panels have been distinguished by their craftsmanship since 1992

Simply a better panel



9 benefits for you

- 1 Dimensional stability and high strength of the panel
- 2 Elimination of surface cracks
- 3 Natureplus certification
- 4 No need to sort the panels
- 5 Smaller offcut due to the flexibility of formats
- 6 Uniform quality for many applications
- 7 Less risk of complaints
- 8 Saving you time and money
- 9 Maximum satisfaction for your customers

Exclusively central timber

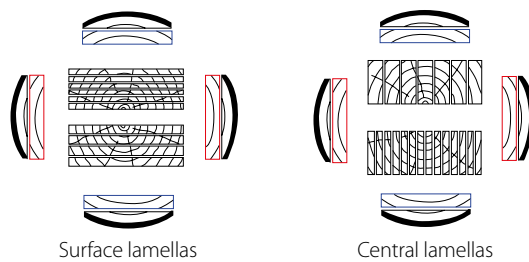

- For the production of all lamellas, we use only central timber from trunk thicknesses of 18–25 cm, which is characterized mainly by small and healthy knots
- We sort the lamellas according to internal regulations, which go beyond the requirements of the standards
- Surface lamellas are always tangential
- The central lamellas are always radial
- We discard the unplanned lamellas and use them for heating the dryers

Compact centre and panel section



- For the centres, we use mainly radial lamellas with a width of max. 63 mm (usually 37 mm – 59 mm)
- We glue all the central lamellas in the joints
- We repair the middle layers
- The middle layer is compact and closed
- We perform the output inspection personally

NOVATOP QUALITY

CONTENT

Minimization of
cracks and manual
repair of defects



- We dry the timber to 7–8%
- We always assemble the surface lamellas with the right side up on the visual side of the panel
- We glue the surface lamellas in joints by means of high side down pressure
- We repair A, B, C qualities
- We only use **natural knots from branches of our own production**

Gluing



- We glue using melamine adhesive
- PVAC gluing on request (formaldehyde-free) or PU

High formatting
accuracy



- As a standard, we guarantee high accuracy of the basic format ± 2 mm diagonally
- On request, we perform formatting and machining on CNC machines with an accuracy of 0.1 mm

Exceptional
sanding quality



- Quality of sanding corresponds to the grain size of 100
- We guarantee sanding tolerance of ± 0.2 mm

1

2

3

4

5

CONTENT

The assembly instructions contain basic information and recommendations.



 **YouTube**
Video tutorial

1 RECOMMENDED APPLICATIONS

Interior: cladding of walls, ceilings, floors, etc.
Covered exterior: covered roof, pergola soffits, etc.
The panels can also be used as non-visual decking, specifically in worse quality.

2 STORAGE

- The panels must be stored in a dry place and must be protected against weather conditions.
- The panels must be stored on hard and flat surfaces.
- Disposal of packaging materials must be carried out in accordance with the local regulations and directives on waste management.

3 SAFETY AT WORK

When handling the panels, it is necessary to:

- Follow all safety precautions.
- Use protective equipment. We recommend using gloves to prevent possible contamination of the panels and getting a splinter.
- Extreme care must be exercised when working at heights and on lifting platforms.
- Secure the panels against falling and mechanical damage.



4 RECOMMENDED TOOLS FOR ASSEMBLY

- Screws
- Drills, cordless screwdriver, air gun
- Spirit level, meter, carpenter's square,
- Sandpaper
- Glue, sealant
- Ladders, lifting platforms, scaffolding
- Wooden inserts, knots

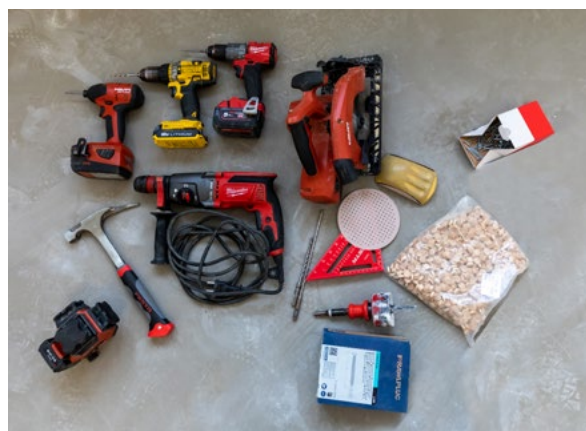

a screw of 3.2 x 50

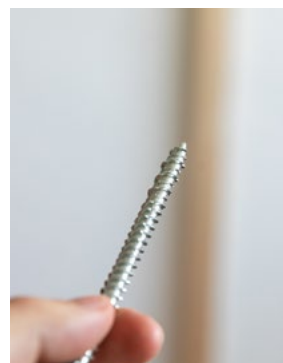

5 GENERAL INFORMATION

- Recommended number of people during assembly is at least 2
- We recommend installing the panels only after all "wet" and "dirty" processes on the construction site.
- The panels can be machined by conventional methods and with standard hand tools. The panels can be cut, drilled, sanded and surface treated in the same way as solid wood.
- We do not recommend treading on visual surfaces of the panels or otherwise polluting them.
- Polluted spots on the panels can be locally wiped with a damp cloth or rubbed with sandpaper.
- We do not recommend exposing the panels to direct sunlight. Exposing the panels before proper surface treatment will thus prevent possible colour changes and differences.
- If the panels are not factory-coated, we recommend treating them with a suitable surface treatment intended for solid wood (e.g. glazing paints, oils, waxes).
- The recommended climate for using the panels indoors is a relative humidity of 40–60% at a temperature of 20 °C. Low humidity can lead to cracks in the wood.

EASY BOARD

ASSEMBLY INSTRUCTIONS

CONTENT

Before the installation, we recommend:

- Thinking about the procedure, the necessary tools and materials, the method of handling and the number of workers for the assembly.
- Thinking about the ideal panel format with regard to the optimized offcut and shape adaptation to window and other openings.
- Creating a plan for laying panels and structures
- Thinking about the position of wiring and prepare all entries and openings. (We recommend taking photos of passages and installations).
- Preparing an even and clean base. The battens are levelled with inserts and a spirit level.

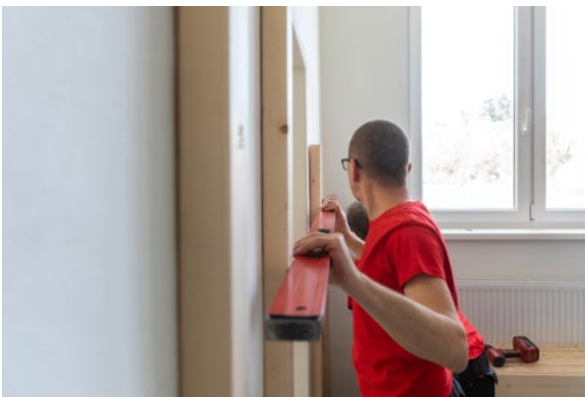

6 TYPES OF APPLICATIONS

- Horizontal and vertical structures.
- Types of applications, see examples of use p. 13–17.
- Panel connections should be set over, see the pictures. Connections that are not set over are more demanding as for accuracy and execution.

We do not recommend:

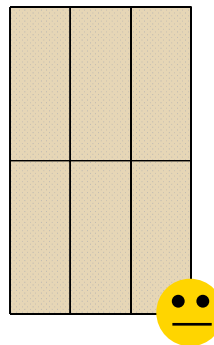

We recommend:

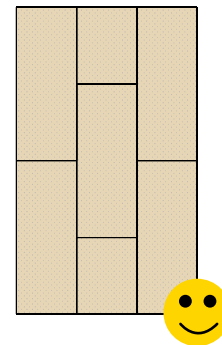

We recommend:

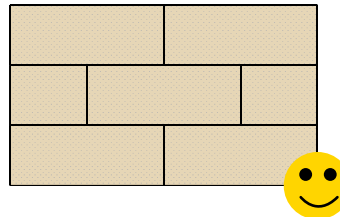

7 ASSEMBLY

1. When starting the assembly, it is necessary to pay attention to the quality of the foundation plane, because unevenness can be reflected in the joints of the next layer.
2. During the work, we constantly check for flatness.
3. The grid of the underlying structure, if it is not flat, is recommended in the range of 60–100 cm.
4. With applications on large areas, emphasis must be placed on proper foundation and fastening of individual panels.
5. It is recommended to sand or bevel the edges of each cut surface.
6. The first panel is installed and nailed or anchored using a screw at the base of the wall; the screw is then additionally covered with a floor/skirting bar.
7. The panels are anchored to the base with screws fitted into the spring (we recommend 3.5 x 50 mm). Their tightening needs to be done carefully so that the spring is not damaged when it is overtightened, and, on the contrary, it does not collide with the groove when it is undertightened.
8. After attaching the panel, it is necessary to check the flatness and accuracy of the attachment.
9. Continue with other panels; during installation, take care not to damage the panels that have already been installed.

EASY BOARD ASSEMBLY INSTRUCTIONS

CONTENT

10. It is ideal to first lay the entire strip (for horizontal and vertical laying), then assemble the next row.
11. If the panel is not exceptionally loaded at the transversal joint, the transversal joint does not have to be at the grid. The longitudinal and transverse joints can both be outside the base.
12. If the panel is weakened by, for example, an opening, or if it needs to be attached outside of the spring in the surface, we recommend using wire: the opening is milled, a screw is inserted into the surface, the opening is then filled with a little knot and the surface is sanded.
13. To achieve maximum strength or wind bracing of the structure, it is possible to glue the panels both between the base and the panel, as well as in the spring and groove. However, here, watch out for the glue leaking onto the surface.
14. It is possible to drill openings for electrical boxes in the boards, mill grooves for e.g. LED lighting, and process them like ordinary wood. We recommend sanding the cut areas.
15. NOVATOP three-layer panels are airtight from a thickness of 19 mm. If the cladding is expected to be completely airtight, it is necessary to apply sealant to the back side of the groove to ensure the airtightness of the joints (Watch out for the airtightness of installations and openings). Watch out for the sealant leaking onto the surface.
16. Lining or other details need to be covered individually.

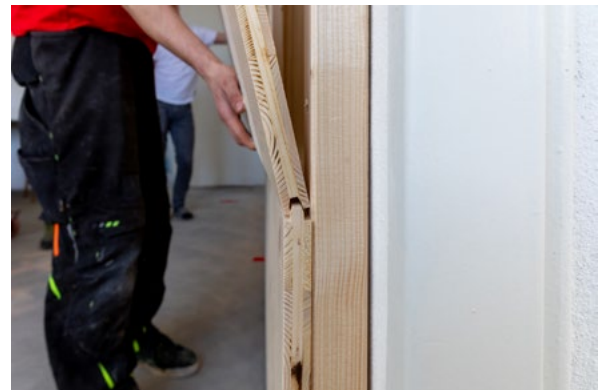
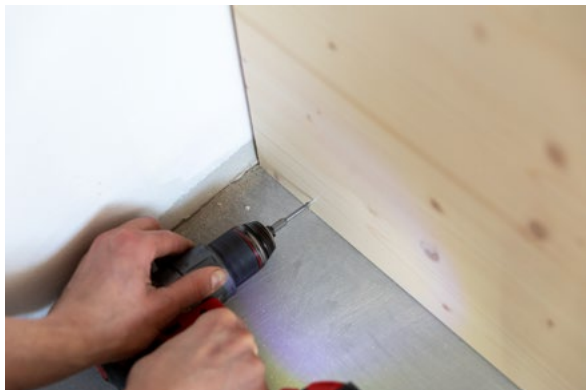

1

2

3

4

5

EASY BOARD ASSEMBLY INSTRUCTIONS

CONTENT



Drilled panels

17. The procedure is the same for drilled panels. If it is necessary to anchor the drilled panels in the surface, we recommend nailing them mechanically or with an air gun. Alternatively, anchoring with screws + wire.
18. If you want to achieve acoustic attenuation with drilled panels, you need to install an absorber (e.g. wood fibre or mineral insulation) in the underlying grid and cover it with fabric (e.g. Fibertex) so that it does not crumble. Or you can use prefabricated NOVATOP ACOUSTIC panels (www.novatop-acoustic.cz).



Untreated wood

8 SURFACE FINISH

- The panels are supplied without surface treatment as standard. Surface treatment can be ordered from 200 m², in the design for interior or covered exterior.
- If the panels are not factory-coated, we recommend treating them with a suitable surface treatment intended for solid wood (e.g. glazing paints, oils, waxes).

- The surface treatment increases the panels' resistance to dirt and UV radiation and extends their aesthetic and functional life. Untreated wood naturally darkens due to oxidation and exposure to light.
- The application of surface treatment is governed by the technological procedure of the manufacturer of the selected coating.
- The panels can be painted individually before installation, or all over after installation. Before surface treatment, we recommend sanding the surface with P 150 or P180. We also recommend treating the visual sides of the panels with surface treatment.
- If the painted panel is damaged during assembly, the repair can be made by gently sanding the affected area and then treating it with the same type of paint. The technological procedure is governed by the instructions of the manufacturer of the selected coating. Repairs are usually visually noticeable.



Drilled profile with surface treatment

1

2

3

4

5

CONTENT

9 MAINTENANCE

- Recommended climate in the interior: relative humidity 40–60%, temperature of approx. 20 °C. Low humidity may cause cracks in the wood.
- For routine wood maintenance, use a soft dry cloth, a soft sponge or a vacuum cleaner with an attachment (dusting brush).
- In case of moderate soiling, cleaning agents intended for wooden surfaces can be used.
- Local damage (e.g. alcohol marker, scratches) can be repaired by: fine sanding, followed by application of the same type of paint. Repairs are usually visually noticeable.

Warning:

- Do not use excessive amounts of water.
- When placing decorations, paintings, shelves, etc., it is necessary to take into account that UV radiation may change the shade of the surrounding surface ("burning out" of the contours). Repairs are usually visually noticeable.
- Visual changes in the paint, such as a change in shade or loss of gloss, are a natural sign of aging and are not grounds for complaint
- The panels must be protected from direct exposure to moisture, such as condensate from air conditioning, running or dripping water, etc.

10 WARRANTY TERMS

The warranty for the panels is governed by the valid General Terms and Conditions of the Manufacturer – AGROP NOVA a.s.

Warning:

The manufacturer does not assume liability for any damage

- incorrect handling,
- improper storage,
- incorrect processing,
- improper use and maintenance.

Visual changes in the wood and the paint, such as a change in shade or loss of gloss, are a natural sign of aging and are not grounds for complaint.



Complaint
report

1

2

3

4

5

NOTES

CONTENT

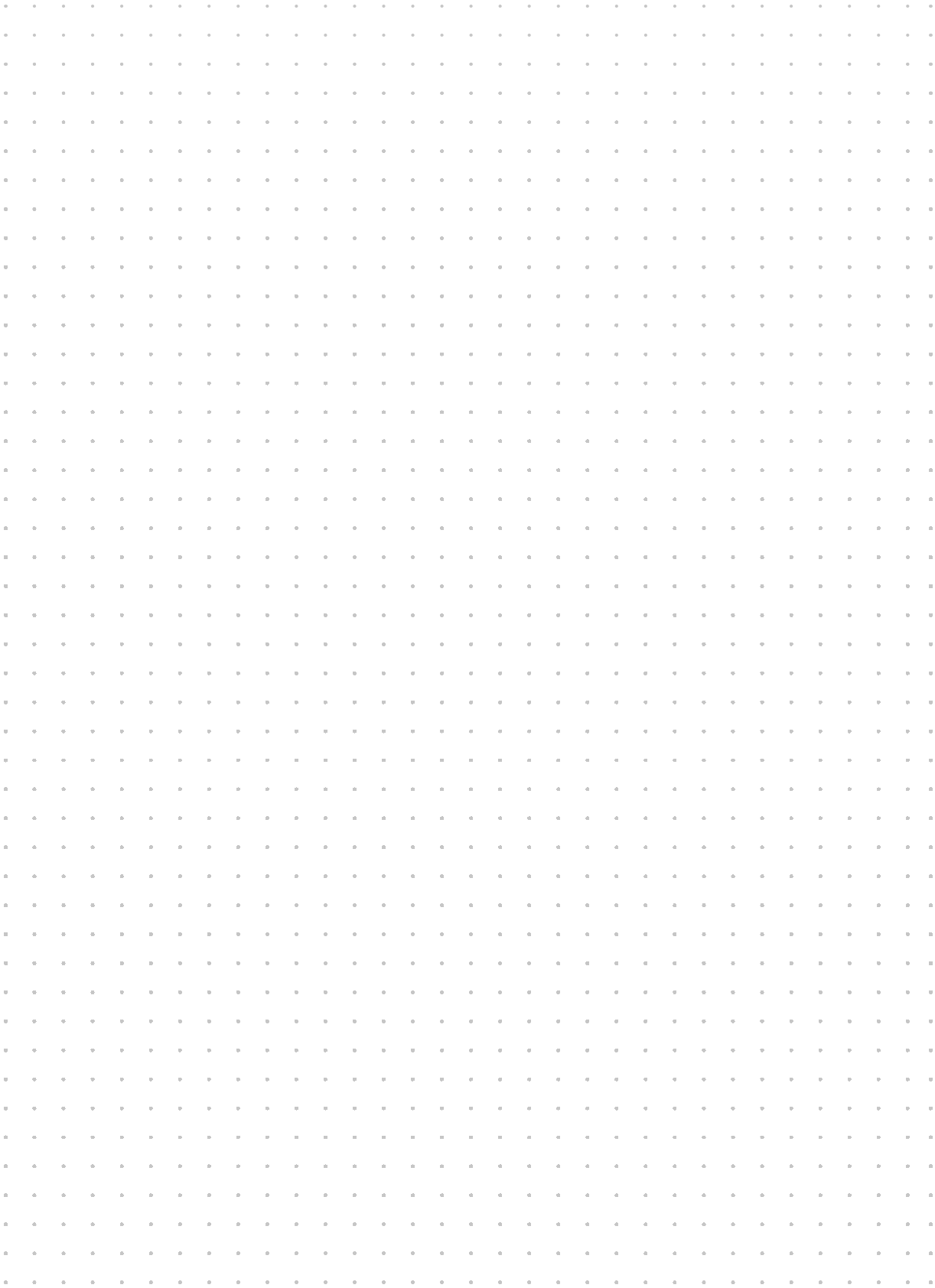

EXAMPLES OF APPLICATIONS

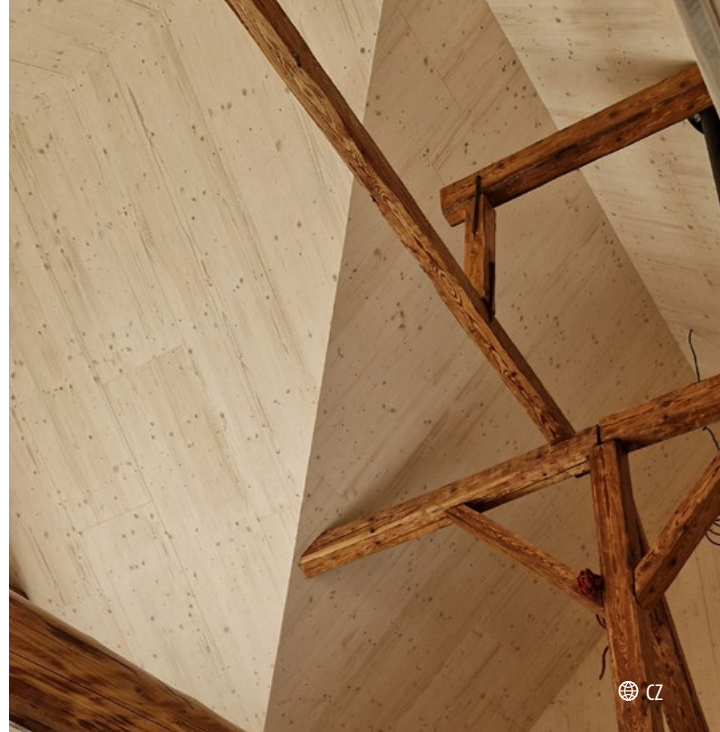



novatop-easyboard.com

Manufacturer: AGROP NOVA a.s.
Ptenský Dvůrek 99 • 798 43 Ptení
Czech Republic • Tel.: +420 582 397 856
novatop@agrop.cz • www.novatop-system.com

Manufacturer certificates:

